

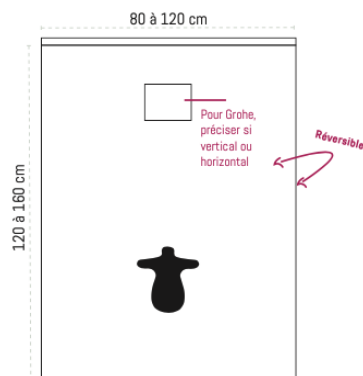



# FICHE TECHNIQUE

## FAÇADE HABILLAGE BÂTI SUPPORT *SUR MESURE*



# L'AJUSTÉ

FAÇADE HABILLAGE BÂTI SUPPORT   	
DESCRIPTIF	Façade habillage bâti support
REF.	Voir tableau des références sur catalogue (BATIPC_)
ASPECT	Relief pierre
MATIÈRE	Couleur teintée dans la masse par gel-coat sanitaire antibactérien ISO NPG (NF EN14688), et certifié anti-prolifération de bactéries selon la méthode JIS Z 2801 - Renforcé fibre de verre, résine et panneau de particules traité
COULEUR	Nuancier 9 couleurs / Option RAL au choix
ÉPAISSEUR	2,5 cm
LARGEUR	80 à 120 cm
HAUTEUR	120 à 160 cm
AJUSTAGE	Re-coupable (scie sauteuse / scie circulaire lame carbure / scie cloche)
EMBALLAGE	Carton renforcé
CONDITIONNEMENT	Unitaire
POIDS	11 kg/m <sup>2</sup>
ENTRETIEN	Facile – Tout type de produit d'entretien et de détachant
CONSEIL DE POSE	Fixation obtenue par serrage mécanique entre WC et Châssis bâti-support

# FICHE DE COTES – BON DE COMMANDE

## FACADE HABILLAGE BÂTI SUPPORT *SUR MESURE*

L'AJUSTÉ

DATE	
ENTREPRISE	
REF CHANTIER	
MARQUE BATI	
COULEUR	
QUANTITÉ	

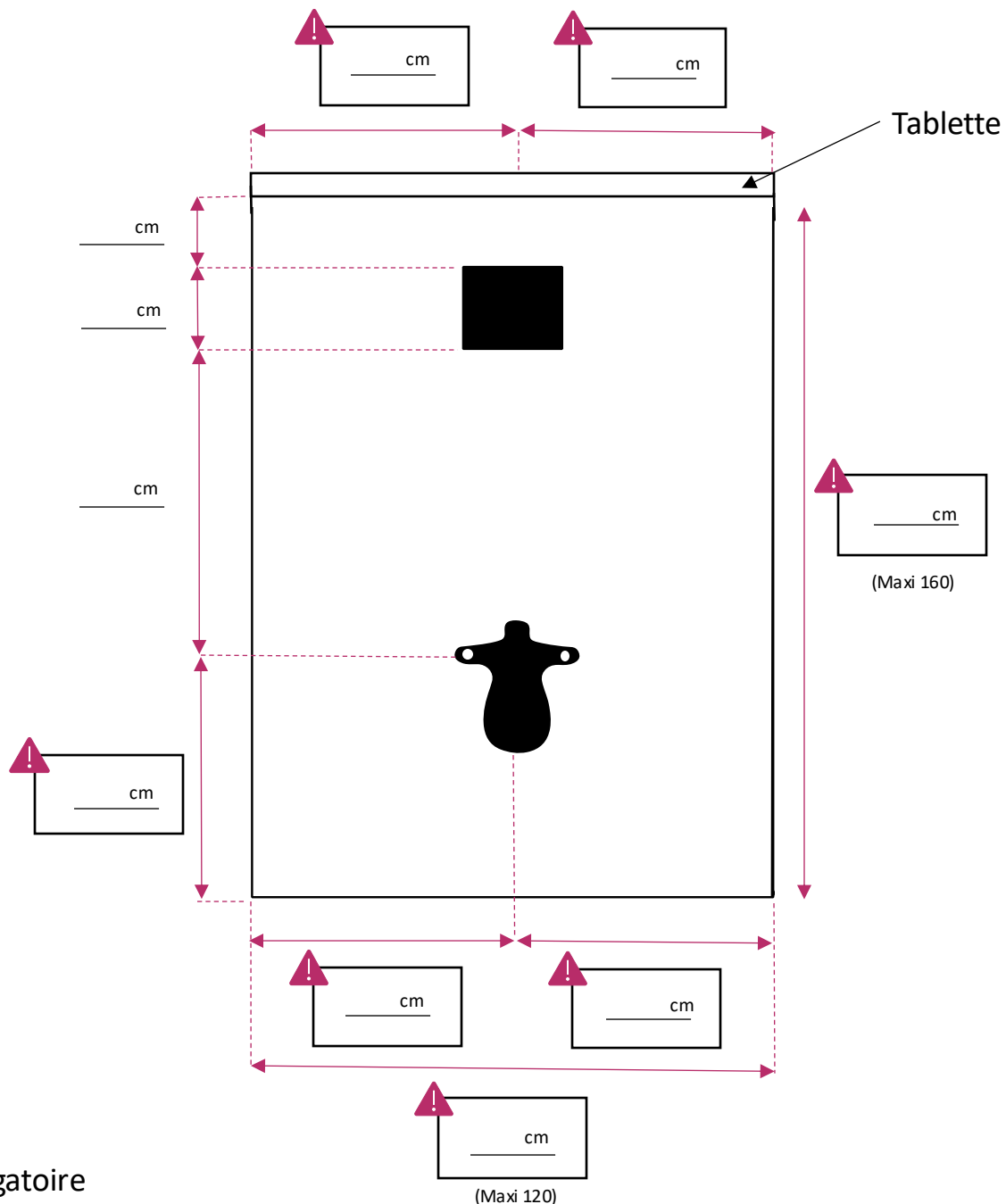

⚠ Obligatoire

25 mars 2025

# Façade habillage bâti support

## OPTION JAMBAGES / RETOURS

Plus value chant  
Ref. TOPPCCS1

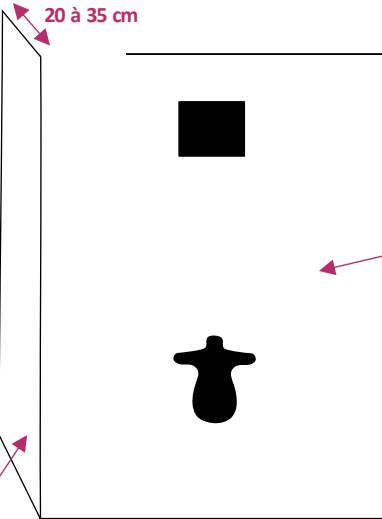
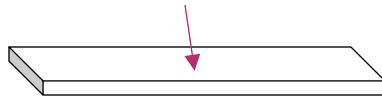

Plus value retour  
Ref. BATIJAMBG

Plus value chant  
Ref. TOPPCCS1

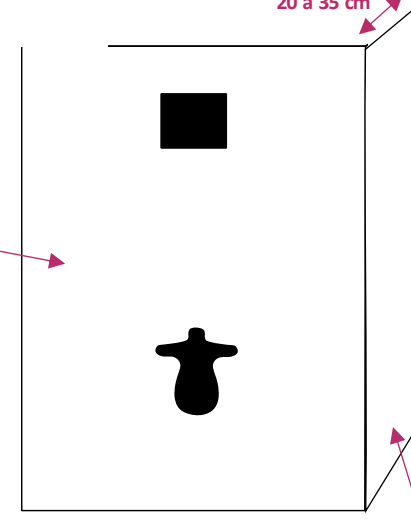

Plus value retour  
Ref. BATIJAMBD

Ref. BATIPC

Plus value chants x2  
Ref. TOPPCCS2

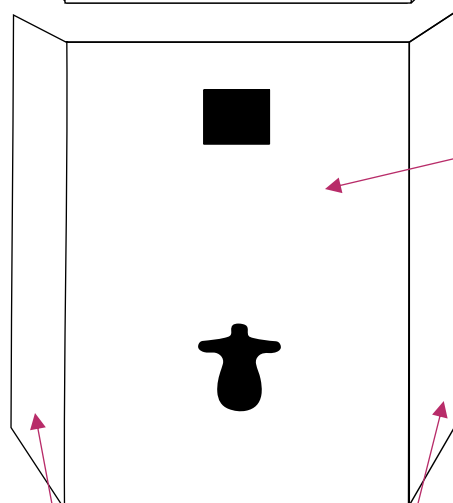
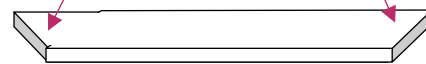

Ref. BATIPC

Plus value retours x2  
Ref. BATIJAMBDG

# Façade habillage bâti support

## OPTION JAMBAGES / RETOURS

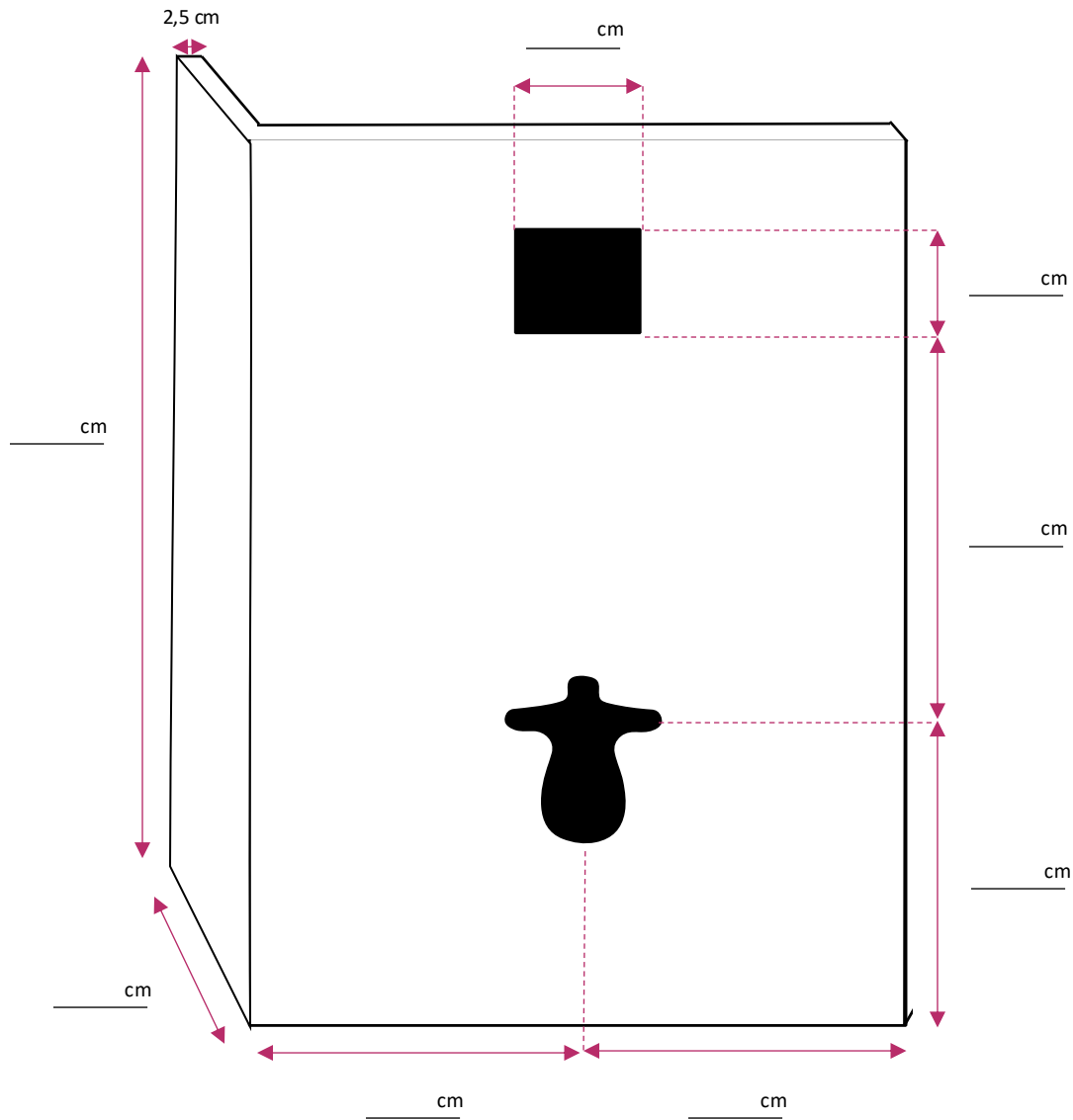

# Façade habillage bâti support

## OPTION JAMBAGES / RETOURS

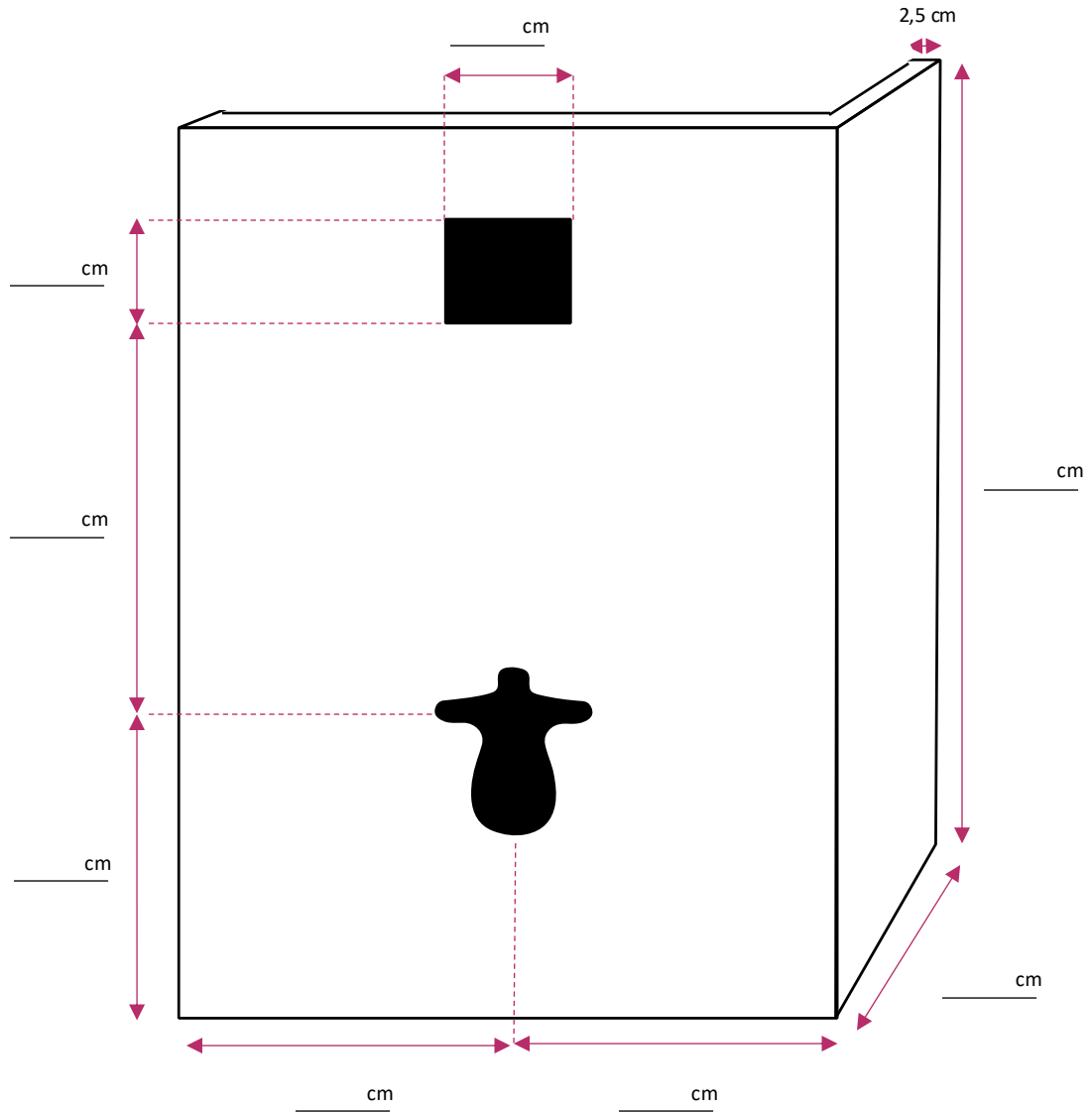

# Façade habillage bâti support

## OPTION JAMBAGES / RETOURS

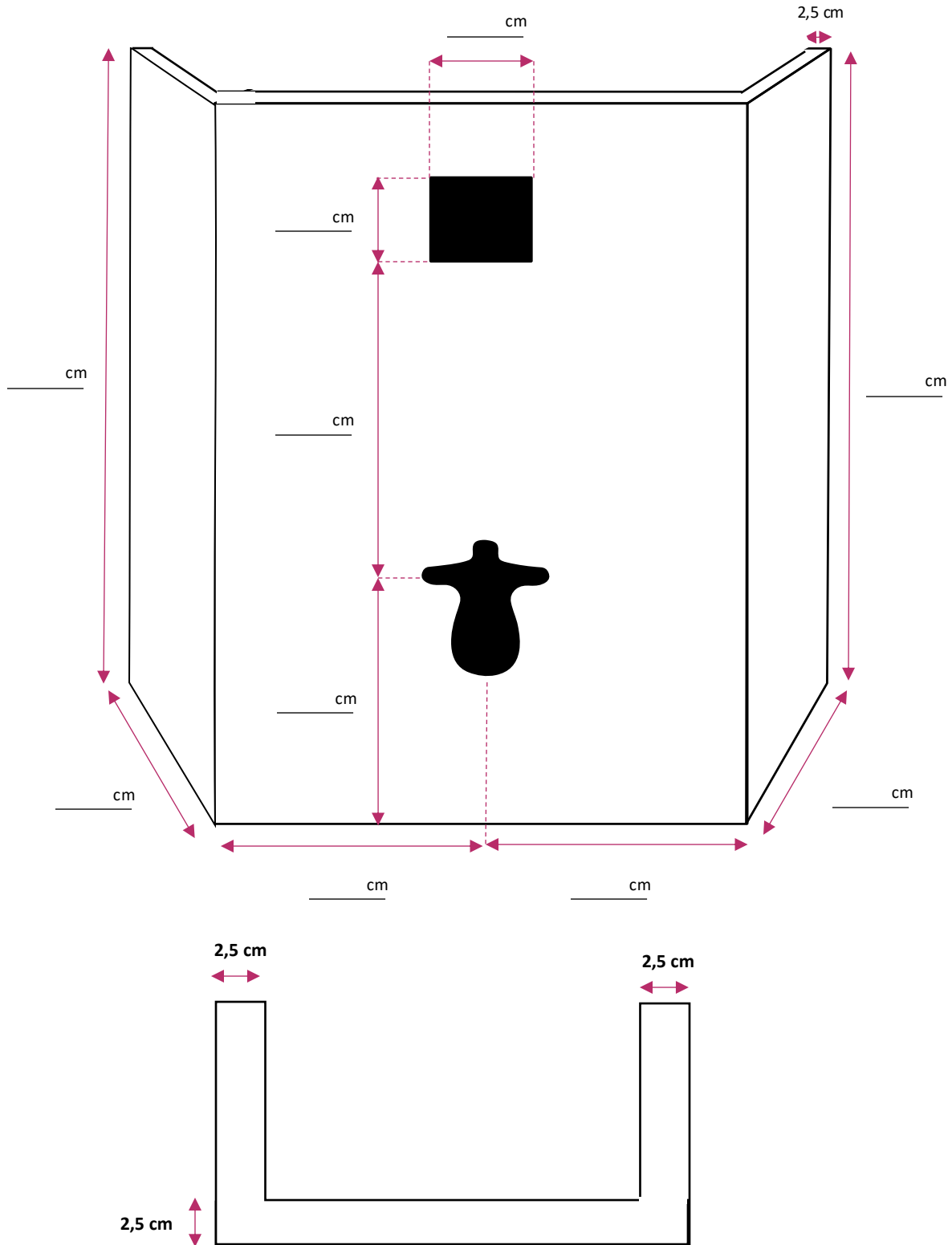

# Façade habillage bâti support

## OPTION JAMBAGES / RETOURS

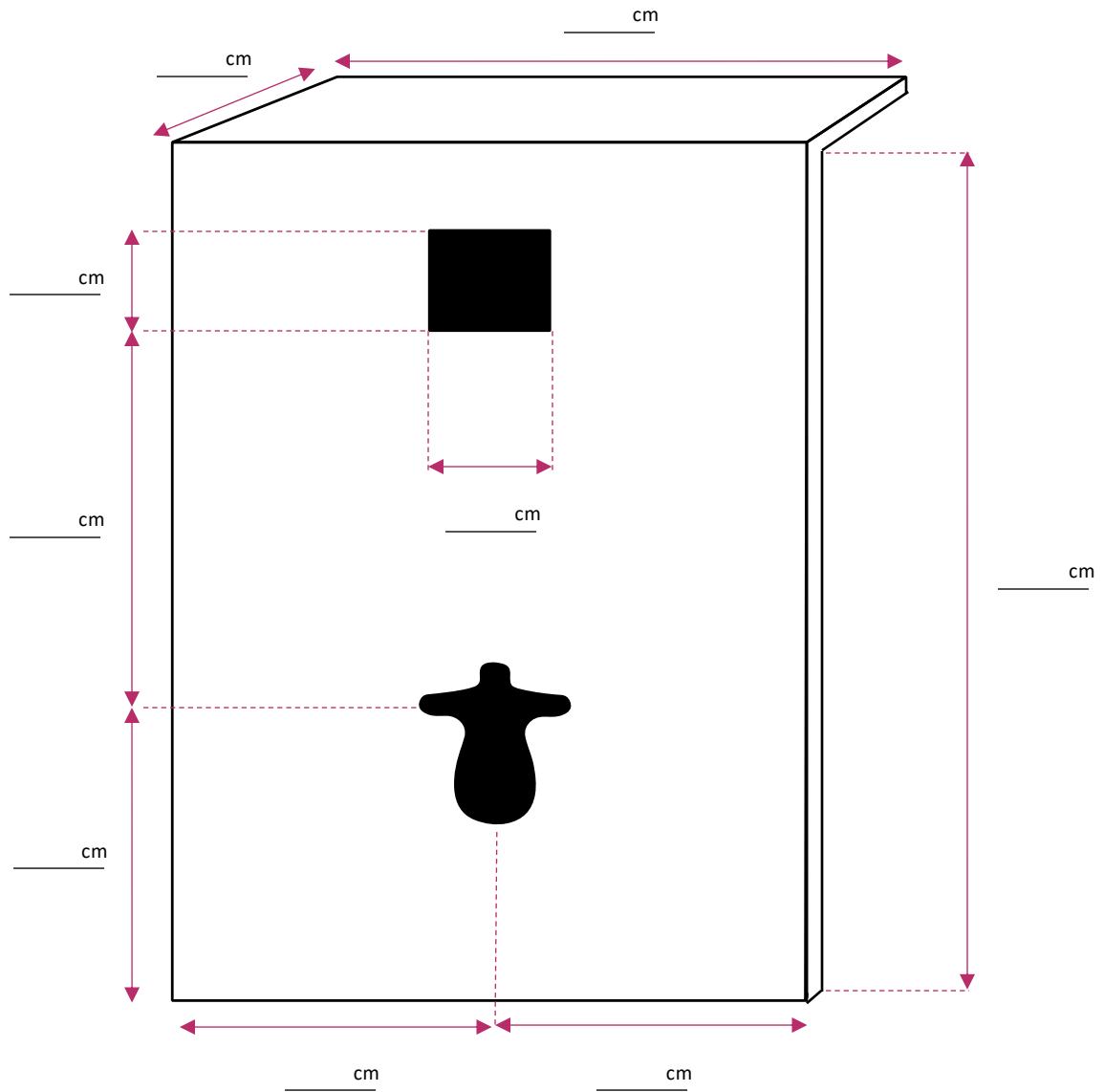

**Vue de côté**

